

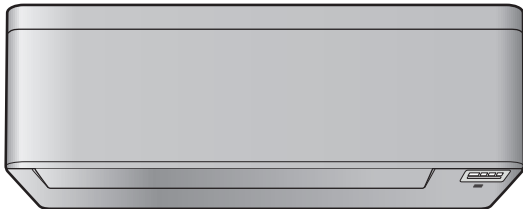

User reference guide

Daikin room air conditioner



Download the
ONECTA app

 **STAND BY ME**
Discover our service offer

CTXA15C2V1BW
FTXA20C2V1BW
FTXA25C2V1BW
FTXA35C2V1BW
FTXA42C2V1BW
FTXA50C2V1BW

CTXA15C2V1BS
FTXA20C2V1BS
FTXA25C2V1BS
FTXA35C2V1BS
FTXA42C2V1BS
FTXA50C2V1BS

CTXA15C2V1BB
FTXA20C2V1BB
FTXA25C2V1BB
FTXA35C2V1BB
FTXA42C2V1BB
FTXA50C2V1BB

Table of Contents

1	About the documentation	4
1.1	About this document	4
1.2	Meaning of warnings and symbols	4
2	User safety instructions	6
2.1	General	6
2.2	Instructions for safe operation	7
3	About the system	11
3.1	Indoor unit	11
3.1.1	Indoor unit display	12
3.2	About the user interface	12
3.2.1	Components: Wireless remote control	13
3.2.2	Status: Wireless remote control LCD	13
3.2.3	To operate the wireless remote control	15
4	Before operation	16
4.1	Overview: Before operation	16
4.2	To mount the wireless remote control holder	16
4.3	To insert the batteries	16
4.4	The clock setting	17
4.4.1	To set the clock	17
4.5	Brightness of the indoor unit display	18
4.5.1	To set the brightness of the indoor unit display	18
4.6	To turn on the power supply	18
4.7	To change indoor unit position setting	18
5	Operation	20
5.1	Operation range	20
5.2	When to use which feature	20
5.3	Operation mode and temperature setpoint	21
5.3.1	To start/stop operation mode and to set the temperature	22
5.4	Airflow rate	22
5.4.1	To adjust the airflow rate	23
5.5	Airflow direction	23
5.5.1	To adjust vertical airflow direction	24
5.5.2	To adjust horizontal airflow direction	24
5.5.3	To use 3D airflow direction	24
5.6	Comfort airflow and Intelligent eye operation	24
5.6.1	Comfort airflow operation	24
5.6.2	Intelligent eye operation	26
5.6.3	To start/stop Comfort and Intelligent eye operation	26
5.7	Powerful operation	27
5.7.1	To start/stop Powerful operation	27
5.8	Econo and Outdoor unit quiet operation	27
5.8.1	Econo operation	27
5.8.2	Outdoor unit quiet operation	28
5.8.3	To start/stop Econo and Outdoor unit quiet operation	28
5.9	Flash Streamer (air cleaning) operation	29
5.9.1	To start/stop Flash Streamer (air cleaning) operation	29
5.10	OFF/ON timer operation	29
5.10.1	24 hour clock OFF/ON timer setting	30
5.10.2	12 hour countdown OFF/ON timer setting	31
5.11	Weekly timer operation	32
5.11.1	To set Weekly timer operation	33
5.11.2	To copy reservations	34
5.11.3	To confirm reservations	35
5.11.4	To deactivate and reactivate Weekly timer operation	35
5.11.5	To delete reservations	35
5.12	Wireless LAN connection	36
5.12.1	Precautions when using the wireless LAN	36
5.12.2	To install the ONECTA app	37
5.12.3	To set the wireless connection	37
6	Energy saving and optimum operation	41

7	Maintenance and service	43
7.1	Overview: Maintenance and service	43
7.2	To clean the indoor unit and wireless remote control	44
7.3	To clean the front panel	44
7.4	To open the front panel	45
7.5	About the air filters	45
7.6	To clean the air filters	46
7.7	To clean the titanium apatite deodorising filter and the silver particle filter (Ag-ion filter)	47
7.8	To replace the titanium apatite deodorising filter and the silver particle filter (Ag-ion filter)	48
7.9	To close the front panel	48
7.10	To remove the front panel	49
7.11	To take following items into account before a long idle period	49
8	Troubleshooting	51
8.1	Symptoms that are NOT system malfunctions	53
8.1.1	Symptom: A sound like water flowing is heard	53
8.1.2	Symptom: A blowing sound is heard	53
8.1.3	Symptom: A ticking sound is heard	53
8.1.4	Symptom: A whistling sound is heard	53
8.1.5	Symptom: A clicking sound during operation or idle time is heard	53
8.1.6	Symptom: A clapping sound is heard	54
8.1.7	Symptom: White mist comes out of a unit (Indoor unit, outdoor unit)	54
8.1.8	Symptom: The units can give off odours	54
8.1.9	Symptom: The outdoor fan rotates while the air conditioner is not in operation	54
8.1.10	Symptom: Airflow rate setting does NOT resume when Comfort airflow is deactivated by ONECTA app.	54
8.1.11	Symptom: Some operation icons are not visible on the wireless remote control, or some functions cannot be activated in the ONECTA app	54
8.1.12	Symptom: In ONECTA app, powerful operation is NOT indicated as active	54
8.2	Solving problems based on error codes	54
8.3	Troubleshooting for wireless LAN connection	56
9	Disposal	58
10	Glossary	59

1 About the documentation

1.1 About this document

Thank you for purchasing this product. Please:

- Keep the documentation for future reference.

Target audience

End users



INFORMATION

This appliance is intended to be used by expert or trained users in shops, in light industry, and on farms, or for commercial and household use by lay persons.

Documentation set

This document is part of a documentation set. The complete set consists of:

- **General safety precautions:**
 - Safety instructions that you must read before operating your system
 - Format: Paper (in the box of the indoor unit)
- **Operation manual:**
 - Quick guide for basic usage
 - Format: Paper (in the box of the indoor unit)
- **User reference guide:**
 - Detailed step-by-step instructions and background information for basic and advanced usage
 - Format: Digital files on <https://www.daikin.eu>. Use the search function 🔍 to find your model.

Latest revisions of the supplied documentation may be available on the regional Daikin website or via your installer.

Scan the QR code below to find the full documentation set and more information about your product on Daikin website.



The original instructions are written in English. All other languages are translations of the original instructions.

1.2 Meaning of warnings and symbols



DANGER

Indicates a situation that results in death or serious injury.



DANGER: RISK OF ELECTROCUTION

Indicates a situation that could result in electrocution.

**DANGER: RISK OF BURNING/SCALDING**

Indicates a situation that could result in burning/scalding because of extreme hot or cold temperatures.

**DANGER: RISK OF EXPLOSION**

Indicates a situation that could result in explosion.

**WARNING**

Indicates a situation that could result in death or serious injury.

**WARNING: FLAMMABLE MATERIAL**

A2L

WARNING: MILDLY FLAMMABLE MATERIAL

The refrigerant inside this unit is mildly flammable.

**CAUTION**

Indicates a situation that could result in minor or moderate injury.

**NOTICE**

Indicates a situation that could result in equipment or property damage.

**INFORMATION**

Indicates useful tips or additional information.

Symbols used on the unit:

Symbol	Explanation
	Before installation, read the installation and operation manual, and the wiring instruction sheet.
	Before performing maintenance and service tasks, read the service manual.
	For more information, see the installer and user reference guide.
	The unit contains rotating parts. Be careful when servicing or inspecting the unit.

Symbols used in the documentation:

Symbol	Explanation
	Indicates a figure title or a reference to it. Example: "▲ 1-3 Figure title" means "Figure 3 in chapter 1".
	Indicates a table title or a reference to it. Example: "■ 1-3 Table title" means "Table 3 in chapter 1".

2 User safety instructions

Always observe the following safety instructions and regulations.

2.1 General



WARNING

If you are NOT sure how to operate the unit, contact your installer.



WARNING

This appliance can be used by children aged from 8 years and above and persons with reduced physical, sensory or mental capabilities or lack of experience and knowledge if they have been given supervision or instruction concerning use of the appliance in a safe way and understand the hazards involved.

Children SHALL NOT play with the appliance.

Cleaning and user maintenance SHALL NOT be made by children without supervision.



WARNING

To prevent electrical shocks or fire:

- Do NOT rinse the unit.
- Do NOT operate the unit with wet hands.
- Do NOT place any objects containing water on the unit.



CAUTION

- Do NOT place any objects or equipment on top of the unit.
- Do NOT sit, climb or stand on the unit.

- Units are marked with the following symbol:



This means that electrical and electronic products may NOT be mixed with unsorted household waste. Do NOT try to dismantle the system yourself: dismantling the system, treatment of the refrigerant, of oil and of other parts MUST be done by an authorised installer and MUST comply with applicable legislation.

Units MUST be treated at a specialised treatment facility for reuse, recycling and recovery. By ensuring this product is disposed of correctly, you will help to prevent potential negative consequences for the environment and human health. For more information, contact your installer or local authority.

- Batteries are marked with the following symbol:



This means that the batteries may NOT be mixed with unsorted household waste. If a chemical symbol is printed beneath the symbol, this chemical symbol means that the battery contains a heavy metal above a certain concentration.

Possible chemical symbols are: Pb: lead (>0.004%).

Waste batteries MUST be treated at a specialised treatment facility for reuse. By ensuring waste batteries are disposed of correctly, you will help to prevent potential negative consequences for the environment and human health.

2.2 Instructions for safe operation



A2L

WARNING: MILDLY FLAMMABLE MATERIAL

The refrigerant inside this unit is mildly flammable.



CAUTION

The indoor unit contains radio equipment, minimum separation distance between the radiating part of the equipment and the user is 10 cm.



CAUTION

Do NOT insert fingers, rods or other objects into the air inlet or outlet. When the fan is rotating at high speed, it will cause injury.



WARNING

- Do NOT modify, disassemble, remove, reinstall or repair the unit yourself as incorrect dismantling or installation may cause an electrical shock or fire. Contact your dealer.
- In case of accidental refrigerant leaks, make sure there are no naked flames. The refrigerant itself is entirely safe, non-toxic and mildly flammable, but it will generate toxic gas when it accidentally leaks into a room where combustible air from fan heaters, gas cookers, etc. is present. Always have qualified service personnel confirm that the point of leakage has been repaired or corrected before resuming operation.



CAUTION

ALWAYS use the wireless remote control or other user interface (if applicable) to adjust the position of the flaps and louvers. When the flaps and louvers are swinging and you move them forcibly by hand, the mechanism will break.



CAUTION

NEVER expose little children, plants or animals directly to the airflow.



WARNING

Do NOT place a flammable spray bottle near the air conditioner and do NOT use sprays near the unit. Doing so may result in a fire.



CAUTION

Do NOT operate the system when using a room fumigation-type insecticide. Chemicals could collect in the unit, and endanger the health of people who are hypersensitive to chemicals.

**WARNING**

- The refrigerant inside the unit is mildly flammable, but normally does NOT leak. If the refrigerant leaks in the room and comes in contact with fire from a burner, a heater, or a cooker, this may result in fire, or the formation of a harmful gas.
- Turn OFF any combustible heating devices, ventilate the room, and contact the dealer where you purchased the unit.
- Do NOT use the unit until a service person confirms that the part from which the refrigerant leaked has been repaired.

**WARNING**

- Do NOT pierce or burn refrigerant cycle parts.
- Do NOT use cleaning materials or means to accelerate the defrosting process other than those recommended by the manufacturer.
- Be aware that the refrigerant inside the system is odourless.

**WARNING**

The appliance shall be stored so as to prevent mechanical damage and in a well-ventilated room without continuously operating ignition sources (e.g. open flames, an operating gas appliance, or an operating electric heater). The room size shall be as specified in the General safety precaution.

**DANGER: RISK OF ELECTROCUTION**

To clean the air conditioner or air filter, be sure to stop operation and turn all power supplies OFF. Otherwise, an electrical shock and injury may result.

**CAUTION**

After a long use, check the unit stand and fitting for damage. If damaged, the unit may fall and result in injury.

**WARNING**

Be careful with ladders when working in high places.



WARNING

Improper detergents or cleaning procedure may cause damage on plastic components or water leakage. Splashed detergent on electric components, such as motors, may cause failure, smoke or ignition.



DANGER: RISK OF ELECTROCUTION

Before cleaning, be sure to stop the operation, turn the breaker OFF or pull out the supply cord. Otherwise, an electrical shock and injury may result.



WARNING

Stop operation and shut OFF the power if anything unusual occurs (burning smells etc.).

Leaving the unit running under such circumstances may cause breakage, electrical shock or fire. Contact your dealer.

3 About the system



A2L

WARNING: MILDLY FLAMMABLE MATERIAL

The refrigerant inside this unit is mildly flammable.

**CAUTION**

The indoor unit contains radio equipment, minimum separation distance between the radiating part of the equipment and the user is 10 cm.

**NOTICE**

Do NOT use the system for other purposes. In order to avoid any quality deterioration, do NOT use the unit for cooling precision instruments, food, plants, animals, or works of art.

3.1 Indoor unit

**CAUTION**

Do NOT insert fingers, rods or other objects into the air inlet or outlet. When the fan is rotating at high speed, it will cause injury.

**INFORMATION**

The sound pressure level is less than 70 dBA.

**WARNING**

- Do NOT modify, disassemble, remove, reinstall or repair the unit yourself as incorrect dismantling or installation may cause an electrical shock or fire. Contact your dealer.
- In case of accidental refrigerant leaks, make sure there are no naked flames. The refrigerant itself is entirely safe, non-toxic and mildly flammable, but it will generate toxic gas when it accidentally leaks into a room where combustible air from fan heaters, gas cookers, etc. is present. Always have qualified service personnel confirm that the point of leakage has been repaired or corrected before resuming operation.

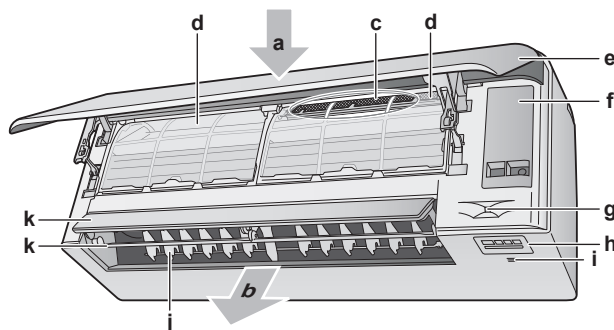

- a Air inlet
- b Air outlet
- c Titanium apatite deodorising filter and silver particle filter (Ag-ion filter)
- d Air filter
- e Front panel
- f Service cover
- g Intelligent eye sensor
- h Display

- i** Room temperature and humidity sensor
- j** Louvers (vertical blades)
- k** Flaps (horizontal blades)

Note: Position of titanium apatite deodorising filter and silver particle filter is interchangeable.

3.1.1 Indoor unit display

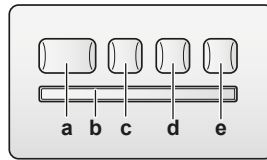

- a** ON/OFF button
- b** Signal receiver
- c** Timer lamp (orange)
- d** Intelligent eye lamp (green)
- e** Wireless adapter ON/OFF button

ON/OFF button

If the wireless remote control (user interface) is missing, you can use the ON/OFF button on the indoor unit to start/stop operation. When operation is started using this button, the following settings are used:

- Operation mode = Automatic
- Temperature setting = 25°C
- Airflow rate = Automatic

3.2 About the user interface

Wireless remote control



INFORMATION

The indoor unit is delivered with the wireless remote control as the user interface. This manual describes only operation with this user interface. If another user interface is connected, refer to the operation manual of the connected user interface.

- **Direct sunlight.** Do NOT expose the wireless remote control to direct sunlight.
- **Dust.** Dust on the signal transmitter or receiver will reduce sensitivity. Wipe off dust with a soft cloth.
- **Fluorescent lights.** Signal communication might be disabled if fluorescent lamps are in the room. In that case, contact your installer.
- **Other appliances.** If the wireless remote control signals operate other appliances, move the other appliances, or contact your installer.
- **Curtains.** Make sure that curtains or other objects do NOT block the signal between the unit and the wireless remote control.



NOTICE

- Do NOT drop the wireless remote control.
- Do NOT let the wireless remote control get wet.

3.2.1 Components: Wireless remote control

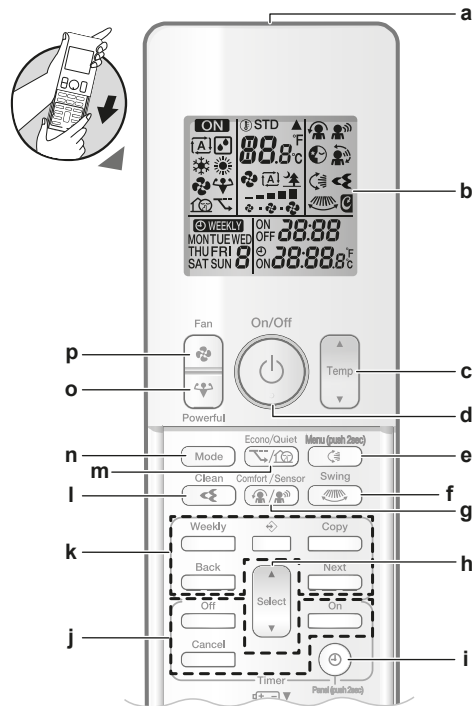

- a Signal transmitter
- b LCD display
- c Temperature adjustment button
- d ON/OFF button
- e Vertical swing and menu (push 2 seconds) button
- f Horizontal swing button
- g Comfort airflow and Intelligent eye operation button
- h Select button
- i Clock and open panel (push 2 seconds) button
- j OFF/ON timer operation buttons
- k Weekly timer operation buttons
- l Flash Streamer (air cleaning) operation button
- m Econo and Outdoor unit quiet operation button
- n Mode button
- o Powerful button
- p Fan button





INFORMATION

Use  (hold for 2 seconds) to open the front panel when you clean the air filters. See "7.4 To open the front panel" [▶ 45].

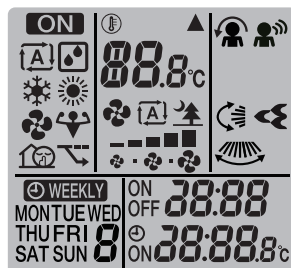
3.2.2 Status: Wireless remote control LCD



Icon	Description
	Operation is active
	Operation mode = Automatic

Icon	Description
	Operation mode = Drying
	Operation mode = Heating
	Operation mode = Cooling
	Operation mode = Fan only
	Powerful operation is active
	Econo operation is active
	Outdoor unit quiet operation is active
	The indoor unit receives a signal from the wireless remote control
	Current temperature setting
	Airflow rate = Automatic
	Airflow rate = Indoor unit quiet
	Airflow rate = High
	Airflow rate = Medium high
	Airflow rate = Medium
	Airflow rate = Medium low
	Airflow rate = Low
	Comfort operation is active
	Intelligent eye is active
	Automatic vertical swing is active
	Automatic horizontal swing is active
	Flash Streamer (air cleaning) is active
	ON timer is active
	OFF timer is active
	Weekly timer is active
	Day of the week
	Current time

3.2.3 To operate the wireless remote control

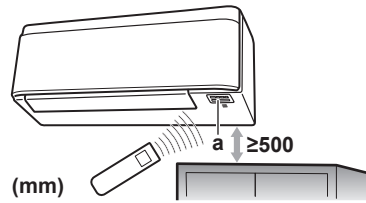

a Infrared signal receiver

Note: Make sure that there are no obstacles within 500 mm under the infrared signal receiver. They may influence reception performance of the wireless remote control.

- 1 Aim the signal transmitter at the infrared signal receiver on the indoor unit (maximum distance for communication is 7 m).

Result: When the indoor unit receives a signal from the wireless remote control, you will hear a sound:

Sound	Description
Beep-beep	Operation starts.
Beep	Setting changes.
Long beep	Operation stops.

4 Before operation

4.1 Overview: Before operation

This chapter describes what you have to do before operating the unit.

Typical workflow

Before operation usually consist of the following stages:

- Fixing the user interface to the wall.
- Inserting the batteries in the user interface.
- Setting the brightness of the user interface display.
- Setting the clock.
- Setting the indoor unit position.
- Turning on the power supply.

4.2 To mount the wireless remote control holder

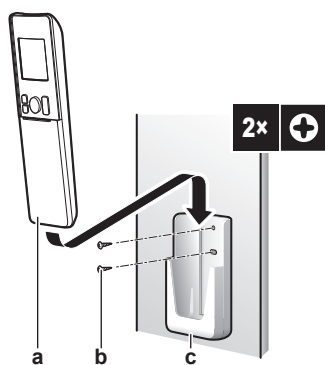

- a** Wireless remote control
- b** Screws (field supply)
- c** Wireless remote control holder

- 1** Choose a place where the signals reach the unit.
- 2** Attach the holder with screws to the wall or a similar location.
- 3** Hang the wireless remote control on the holder.

4.3 To insert the batteries

The batteries will last for about 1 year.

- 1** Remove the front cover.
- 2** Insert both batteries at once.
- 3** Put back the front cover.

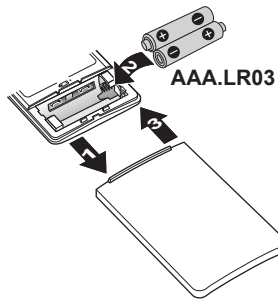

INFORMATION

- Low energy of battery is indicated by flashing of LCD display.
- ALWAYS replace both batteries at once.

4.4 The clock setting

If the indoor unit's internal clock is NOT set to the correct time, the ON timer, OFF timer and weekly timer will NOT operate correctly. The clock must be set again:

- After a circuit breaker has turned the unit OFF.
- After a power failure.
- After replacing batteries in the wireless remote control.

4.4.1 To set the clock

Note: If the time is NOT set, MON, ☉, and 0:00 blink.

- 1 Press ☉.

Result: MON and ☉ blink

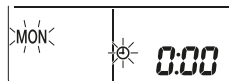

- 2 Press or to set the current day of the week.

Display	Day of the week
MON	Monday
TUE	Tuesday
WED	Wednesday
THU	Thursday
FRI	Friday
SAT	Saturday
SUN	Sunday

- 3 Press ☉.

Result: ☉ blinks.

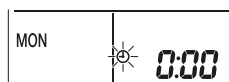

- 4 Press or to set the correct time.

Note: Holding down or increases or decreases the time setting rapidly.

- 5 Press .

Result: Setting is complete.  blinks.

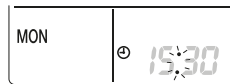

4.5 Brightness of the indoor unit display



Adjust the brightness of the indoor unit display as desired, or turn OFF the display.

4.5.1 To set the brightness of the indoor unit display

- 1 Press  for at least 2 seconds.

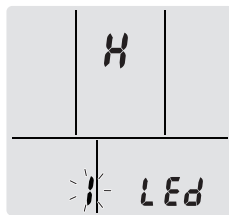
Result: The menu  appears on the display.  is blinking.



- 2 Press .
- 3 Press  or  to change the setting as follows:



...is blinking	Brightness is...
H	High
L	Low
of	Off

- 4 To confirm the selected setting, press .

Result: The brightness setting is changed.

Note: The display automatically returns to the default screen after 60 seconds. To return to the default screen sooner, press  twice.

4.6 To turn on the power supply

- 1 Turn the circuit breaker on.



Result: The flap of the indoor unit will open and close to set the reference position.

4.7 To change indoor unit position setting

Set the indoor unit position to avoid direct airflow to walls.

- 1 Press  for at least 2 seconds.

Result: The menu  appears on the display.

- 2 Press  or  to change the menu to 3.

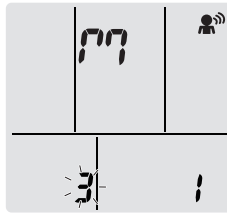

Result: The menu 3 appears on the display. 3 blinks.

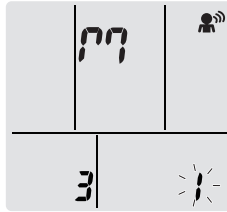

- 3 Press  to select the menu.

Result: 1 blinks.



- 4 Press  or  to change the setting as follows:

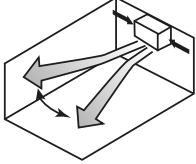
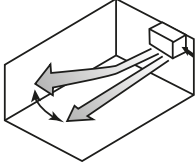
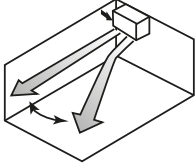

If the unit is...	Symbol	Blinks	Result
In the middle of the wall (factory default setting)	07	1	
≤500 mm from the wall on right	19	2	
≤500 mm from the wall on left	07	3	

Result: The airflow range will be adjusted to avoid direct contact with the wall.

5 Operation



INFORMATION

The indoor unit is delivered with the wireless remote control as the user interface. This manual describes only operation with this user interface. If another user interface is connected, refer to the operation manual of the connected user interface.

5.1 Operation range

Use the system in the following temperature and humidity ranges for safe and effective operation.





	Cooling and drying ^{(a)(b)}	Heating ^(a)
Outdoor temperature	-10~46°C DB	-15~24°C DB
Indoor temperature	18~32°C DB	10~30°C DB
Indoor humidity	≤80% ^(a)	—









^(a) A safety device might stop the operation of the system if the unit runs outside its operation range.

^(b) Condensation and water dripping might occur if the unit runs outside its operation range.

5.2 When to use which feature

You can use the following table to determine which features to use:

Feature	Tasks
Basic features	
 Operation modes and temperature	To start/stop the system and to set the temperature: <ul style="list-style-type: none"> ▪ In Heating and Cooling mode, heat up or cool down a room. ▪ In Fan only mode, blow air in a room without heating or cooling. ▪ In Drying mode, decrease the humidity in a room. ▪ In Automatic mode, an appropriate temperature and operation mode is automatically selected.
 +  Airflow direction	To adjust the airflow direction (swing or fixed position).
 Airflow rate	To adjust the amount of air blown into the room. To run more quietly.
Advanced features	





Feature	Tasks
 Flash Streamer	To remove airborne allergens such as pollen, adjuvant substances... To reduce bad odors.
 Econo	To use the system when you are also using other power-consuming appliances. To save energy.
 Outdoor unit quiet	To decrease the noise level of the outdoor unit. Example: At night.
 Comfort	To automatically adjust the airflow direction to cool down or heat up the room more effectively.
 Intelligent eye	To prevent the air from coming in direct contact with people. To save energy when nobody is in the room.
 Powerful	To cool down or heat up the room quickly.
 ON timer +  OFF timer	To automatically turn ON or OFF the system.
 Weekly timer	To automatically turn ON or OFF the system on a weekly basis.
Additional features	
Wireless LAN connection	To operate the unit using smart appliances.

5.3 Operation mode and temperature setpoint

When. Adjust the system operation mode and set the temperature when you want to:

- Heat up or cool down a room
- Blow air in a room without heating or cooling
- Decrease the humidity in a room

What. The system operates differently, depending on the user selection.

Setting	Description
 Automatic	The system cools down or heats up a room to the temperature setpoint. It automatically switches between cooling and heating if necessary.
 Drying	The system decreases the humidity in a room.
 Heating	The system heats up a room to the temperature setpoint.
 Cooling	The system cools down a room to the temperature setpoint.
 Fan	The system only controls the airflow (airflow rate and airflow direction). The system does NOT control the temperature.

Additional info:

- **Outside temperature.** The system's cooling or heating effect decreases when the outside temperature is too high or too low.
- **Defrost operation.** During heating operation, frost might occur on the outdoor unit and decrease the heating capacity. In that case, the system automatically switches to defrosting operation to remove the frost. During defrosting operation, hot air is NOT blown from the indoor unit.
- **Humidity sensor.** Control the humidity by decreasing the humidity during cooling process.

5.3.1 To start/stop operation mode and to set the temperature



ON: Unit is operating.

A: Operation mode = Automatic

☐: Operation mode = Drying

❄️: Operation mode = Cooling

☀️: Operation mode = Heating

🌀: Operation mode = Fan only

27.0°C: Shows the set temperature.

- 1 Press **Mode** one or more times to select the operation mode.

Result: The mode will be set as follows:



- 2 Press **Power** to **start** operation.

Result: **ON** and the selected mode are displayed on the LCD.

- 3 Press **Temp** or **Temp** one or more times to lower or raise the **temperature**.

Cooling operation	Heating operation	Automatic operation	Drying or Fan only operation
18~32°C	10~30°C	18~30°C	—



Note: When using **drying** or **fan only** mode, you cannot adjust the temperature.

- 4 Press **Power** to **stop** operation.

Result: **ON** disappears from the LCD. The operation lamp goes off.

5.4 Airflow rate

- 1 Press **Airflow** to choose:

	5 airflow rate levels, from "■" to "■"
A	Automatic airflow rate operation
	Indoor unit quiet operation. When the airflow rate is set to "■", the noise from the unit will be reduced.

**INFORMATION**

- If the unit reaches the temperature setpoint in cooling or heating mode, the fan will stop operating.
- When using drying operation mode, you CANNOT adjust the airflow rate setting.

5.4.1 To adjust the airflow rate

- 1 Press to change the airflow setting as follows:



5.5 Airflow direction

When. Adjust the airflow direction as desired.

What. The system directs the airflow differently, depending on the user selection (swinging or fixed position). It does so by moving horizontal blades (flaps) or vertical blades (louvers).

Setting	Airflow direction
Vertical automatic swing	Moves up and down.
Horizontal automatic swing	Moves from side to side.
3-D airflow direction	Moves alternately up and down and from side to side
[—]	Stays in a fixed position.

**CAUTION**

ALWAYS use the wireless remote control or other user interface (if applicable) to adjust the position of the flaps and louvers. When the flaps and louvers are swinging and you move them forcibly by hand, the mechanism will break.

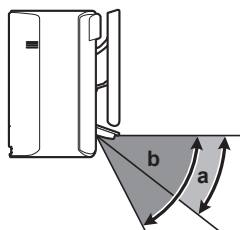

The movable range of the flap varies according to the operation mode. The flap will stop at the upper position when the airflow rate is changed to low during the up and down swing setting.



- a Flap range in cooling or drying operation
- b Flap range in heating or fan only operation

5.5.1 To adjust vertical airflow direction



- 1 Press .

Result:  appears on the LCD. The flaps (horizontal blades) will begin to swing.
- 2 To use fixed position, press  when the flaps reach the desired position.

Result:  disappears from the LCD. The flaps will stop moving.

5.5.2 To adjust horizontal airflow direction

- 1 Press .

Result:  appears on the LCD. The louvers (vertical blades) will begin to swing.
- 2 To use fixed position, press  when the louvers reach the desired position.



Result:  disappears from the LCD. The louvers will stop moving.









INFORMATION

When the unit is installed in a corner of a room, the direction of the louvers should be facing away from the wall. Efficiency will drop if a wall blocks the air.

5.5.3 To use 3D airflow direction

- 1 Press  and .

Result:  and  appear on the LCD. The flaps (horizontal blades) and louvers (vertical blades) will begin to swing.
- 2 To use fixed position, press  and  when the flaps and louvers reach the desired position.

Result:  and  disappear from the LCD. The flaps and the louvers will stop moving.

5.6 Comfort airflow and Intelligent eye operation

You can use Comfort and Intelligent eye operation separately, or combine them.

5.6.1 Comfort airflow operation

The unit will automatically change the direction of the airflow to heat up or cool down the room more effectively. Direct airflow from the unit will be less noticeable.

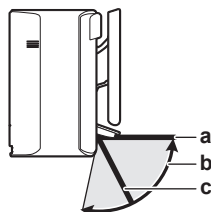

- a Flap position in cooling and dry operation
- b Flap range in heating operation (vertical airflow ON)
- c Flap position in heating operation (vertical airflow OFF)

In cooling and drying

The airflow direction will change to spread the air along the ceiling.

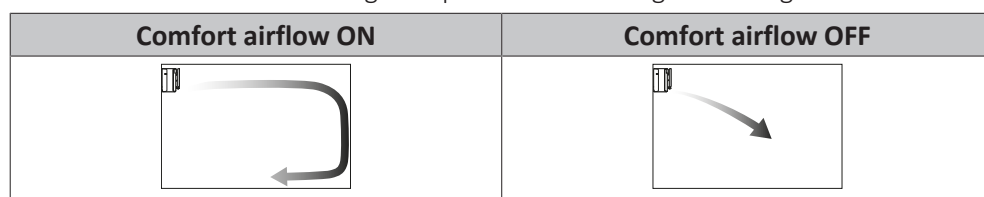

In heating

The airflow direction will change to spread the air along the floor. The unit detects the room and floor temperature and automatically selects 1 of the 3 airflow directions.

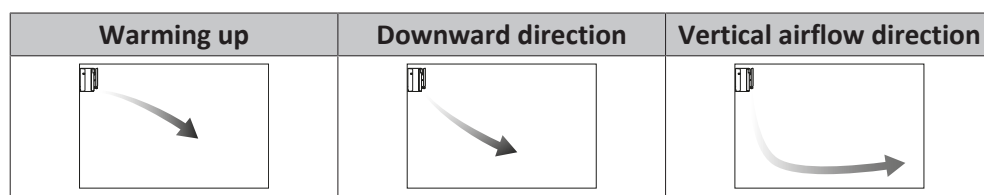

INFORMATION





If you want to deactivate the Vertical airflow function (e.g. in case there is furniture or another object under the unit), refer to ["To turn ON/OFF vertical airflow function" \[▶ 25\]](#). If the Vertical airflow function is deactivated, the airflow will be set to downward direction.



INFORMATION



Powerful and Comfort airflow operation CANNOT be used at the same time. The last selected function takes priority. If the vertical automatic swing is selected, Comfort airflow operation will be cancelled.

To turn ON/OFF vertical airflow function

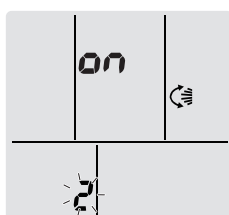
- Press  for at least 2 seconds.
Result: The menu  appears on the display.
- Press  or  to change the menu screen.
Result: The menu  appears on the display.



- Press  to change the setting.
- Press  or  to change the setting.

...is blinking	Vertical airflow function is...
	turned ON
	turned OFF

- To confirm the selected setting press .

Note: The display automatically returns to the default screen after 60 seconds. To return to the default screen sooner, press  twice.

5.6.2 Intelligent eye operation

The system detects movement in the room and automatically adjusts the airflow direction and temperature in order to avoid direct contact with people. If no movement is detected for 20 minutes, the system switches to energy saving operation:

Operation	Energy saving operation
Heating	Temperature is lowered by 2°C.
Cooling and drying	If the temperature in the room is: <ul style="list-style-type: none"> ▪ <30°C, the temperature is raised by 2°C ▪ ≥30°C, the temperature is raised by 1°C
Fan only	Decreases airflow rate.

About the Intelligent eye sensor

 **NOTICE**

- Do NOT hit or push the Intelligent eye sensor. Doing so may lead to malfunction.
- Do NOT place large objects near the Intelligent eye sensor.

 **INFORMATION**

Powerful or Night set mode (OFF timer) CANNOT be used at the same time with Intelligent eye operation. The last selected function takes priority.



- **Detection range.** Up to 9 m.
- **Detection sensitivity.** Changes according to location, the number of persons in the room, temperature range, etc.
- **Detection mistakes.** The sensor may mistakenly detect pets, sunlight, moving curtains, etc.

5.6.3 To start/stop Comfort and Intelligent eye operation

1 Press  one or more times.

Result: The setting will change as follows:



Display	Operation
	Comfort airflow
	Intelligent eye
	Comfort airflow and Intelligent eye
—	Both deactivated

Note: If there are people close to the front of the indoor unit or there are too many people, use both operations at the same time.

2 To stop operation, press  until both symbols disappear from the LCD.

5.7 Powerful operation

This operation quickly maximizes the cooling/heating effect in any operation mode. You can get the maximum capacity.



INFORMATION

Powerful operation CANNOT be used together with Econo, Comfort airflow and Outdoor unit quiet operation. The last selected function takes priority.

Powerful operation will NOT increase the capacity of the unit if it already operates at maximum capacity.

5.7.1 To start/stop Powerful operation

- 1 Press to start.

Result: is displayed on the LCD. Powerful operation runs for 20 minutes; after that, operation returns to the previously set mode.

Mode	Airflow rate
Cooling/Heating/Automatic	<ul style="list-style-type: none"> ▪ To maximize the cooling/heating effect, the capacity of outdoor unit is increased. ▪ The airflow rate is fixed to the maximum setting and CANNOT be changed. ▪ The temperature can be set only in Automatic mode.
Drying	<ul style="list-style-type: none"> ▪ The temperature setting is lowered by 2.5°C. ▪ The airflow rate is slightly increased.
Fan only	The airflow rate is fixed to the maximum setting.

- 2 Press to stop.

Result: disappears from the LCD.

Note: Powerful operation can be set only when the unit is running. If you press or if you change operation mode, operation will be cancelled; disappears from the LCD.

5.8 Econo and Outdoor unit quiet operation

5.8.1 Econo operation

This is a function which enables efficient operation by limiting the maximum power consumption value. This function is useful for cases in which attention should be paid to ensure a circuit breaker will not trip when the product runs alongside other appliances.



INFORMATION

- Powerful and Econo operation CANNOT be used at the same time. The last selected function takes priority.
- Econo operation reduces power consumption of the outdoor unit by limiting the rotation speed of the compressor. If power consumption is already low, Econo operation will NOT further reduce power consumption.

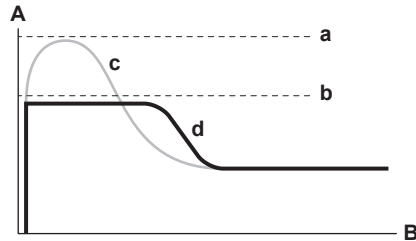

- A** Running current and power consumption
- B** Time
- a** Maximum during normal operation
- b** Maximum during Econo operation
- c** Normal operation
- d** Econo operation

- The diagram is for illustrative purposes only.
- The maximum running current and power consumption of the air conditioner in Econo operation varies with the connected outdoor unit.

5.8.2 Outdoor unit quiet operation

Use Outdoor unit quiet operation when you want to decrease the noise level of the outdoor unit. **Example:** At night.



INFORMATION

- Powerful and Outdoor unit quiet operation CANNOT be used at the same time. The last selected function takes priority.
- This function is only available in Automatic, Cooling, and Heating operation.
- Outdoor unit quiet operation limits the rotation speed of the compressor. If the rotation speed of compressor is already low, Outdoor unit quiet operation will NOT further reduce the compressor rotation speed.

5.8.3 To start/stop Econo and Outdoor unit quiet operation



- 1 Press one or more times.

Result: The setting will change as follows.



Display	Operation
	Econo
	Outdoor unit quiet
	Econo and Outdoor unit quiet
—	Both deactivated

- 2 To stop operation, press until both symbols disappear from the LCD.

Note: Econo operation can be only set when the unit is running. Pressing  cancels the setting and  disappears from the LCD.

Note:  remains on the LCD, even if you turn off the unit using the wireless remote control or indoor unit ON/OFF switch.

5.9 Flash Streamer (air cleaning) operation

Streamer generates a high-speed electron stream with a high oxidizing power, reducing bad odours. Together with the titanium apatite deodorising filter and the air filters, this function cleans the air in the room.



INFORMATION

- The high-speed electrons are generated and go away inside the unit to ensure safe operation.
- The Streamer discharge may generate a fizzing sound.
- If the airflow becomes weak, the Streamer discharge may stop temporarily to prevent ozone smell.

5.9.1 To start/stop Flash Streamer (air cleaning) operation

Prerequisite: Make sure the unit is operating ( is displayed on the wireless remote control LCD).

1 Press .

Result:  is displayed on the LCD and the air in the room is cleaned when the unit is operating.

2 To stop operation, press .

Result:  disappears from the LCD and operation stops.

5.10 OFF/ON timer operation

Timer functions are useful for automatically switching the air conditioner off/on at night or in the morning. You can also use OFF timer and ON timer in combination.

There are two types of OFF/ON timer setting:

- **24 hour clock OFF/ON timer** (default). The unit will stop/start operating at the set time. **Example:** The ON timer is set to 13:30, the unit will start operating at 13:30.
- **12 hour countdown OFF/ON timer.** The unit will stop/start operating after the set number of hours. **Example:** The ON timer is set at 10:30 to 3 hours, the unit will start operating at 13:30.

Note: It is possible to combine both timer setting types.



INFORMATION

Program the timer again in case of:

- A breaker has turned the unit off.
- A power failure.
- After replacing batteries in the wireless remote control.

**INFORMATION**

The clock **MUST** be set correctly before using any timer functions. Refer to "4.4.1 To set the clock" [▶ 17].

5.10.1 24 hour clock OFF/ON timer setting

To start/stop OFF timer operation

- 1 Press **Off** to start.

Result: **0:00** is displayed on the LCD and **OFF** blinks. ☉ and the day of the week disappear from the LCD.



- 2 Press **Select** or **Select** to change the time setting.
- 3 Press **Off** again.

Result: **OFF** and the set time are displayed on the LCD.

Result: The timer lamp lights up.

**INFORMATION**

Each time **Select** or **Select** is pressed, the time setting advances by 10 minutes. Holding the button down will change the setting rapidly.

- 4 To stop operation, press **Cancel**.

Result: **0:00** and **OFF** disappear from the LCD and the timer lamp goes off. ☉ and the day of the week are displayed on the LCD.

**INFORMATION**

When you set the ON/OFF timer, the time setting is stored in the memory. When the wireless remote control batteries are replaced, the remote control keeps the time setting for the ON/OFF timer, but the timer is cancelled.

Night set mode

When the OFF timer is set, the air conditioner automatically adjusts the temperature setting (0.5°C up in cooling, 2.0°C down in heating) to prevent excessive cooling/heating and ensure a comfortable sleeping temperature.

To start/stop ON timer operation

- 1 Press **On** to start.

Result: **6:00** is displayed on the LCD and **ON** blinks. ☉ and the day of the week disappear from the LCD.

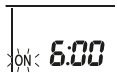

- 2 Press **Select** or **Select** to change the time setting.
- 3 Press **On** again.

Result: **ON** and the set time are displayed on the LCD. The timer lamp lights up.

**INFORMATION**

Each time **Select** or **Select** is pressed, the time setting advances by 10 minutes. Holding the button down will change the setting rapidly.

- 4 To stop operation, press **Cancel**.

Result: **6:00** and **ON** disappear from the LCD and the timer lamp goes off. ☹ and the day of the week are displayed on the LCD.

To combine OFF timer and ON timer

- 1 To set the timers, refer to "To start/stop OFF timer operation" [▶ 30] and "To start/stop ON timer operation" [▶ 30].

Result: **OFF** and **ON** are displayed on the LCD.

Example:

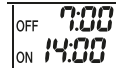
Display	Current time	Set while...	Operation
	6:00	the unit is operating.	Stops at 7:00 and starts at 14:00.
		the unit is NOT operating.	Starts at 14:00.

Note: If the timer setting is active, the current time is NOT displayed on the LCD.

5.10.2 12 hour countdown OFF/ON timer setting

To start/stop countdown OFF/ON timer operation

- 1 Press and hold **Off** or **On** for about 5 seconds; when ▲ blinks, release the button.

Result:

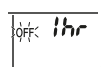

For the OFF timer, **1hr** appears on the LCD and **OFF** blinks, ☹ and the day of the week disappear from the LCD.

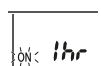

For the ON timer, **1hr** appears on the LCD and **ON** blinks. ☹ and the day of the week disappear from the LCD.

- 2 Press **Select** or **Select** to change the time setting. The time can be set between 1~12 hours. Each pressing of the button increases or decreases the time setting by 1 hour.
- 3 Press **Off** or **On** to confirm the setting.

Result: **OFF** and/or **ON** and the set time are displayed on the LCD. The timer lamp lights up. The time displayed on the LCD will automatically count down by 1 hour for every hour that passes.

Example: If the OFF timer is set to 3 hours, the displayed time will change as follows: 3hr → 2hr → 1hr → blank (OFF)

- 4 To change the setting back to 24 hour OFF/ON timer, repeat step 1 when on the home screen when **OFF** and/or **ON** are NOT blinking.
- 5 To cancel the timer setting, press **Cancel**.

To combine the timer display modes

Different display modes (24 hour and 12 hour countdown OFF/ON timer) can be used for the OFF timer and ON timer simultaneously.

- 1 For setting, see "To start/stop OFF timer operation" [▶ 30], "To start/stop ON timer operation" [▶ 30] and "To start/stop countdown OFF/ON timer operation" [▶ 31].

Example:

Display	Current time	Set while...	Operation
	22:00	the unit is operating.	<ul style="list-style-type: none"> Stops at 1:00 (3 hours after present time) Starts at 6:00. (8 hours after present time)

Note: If the timer setting is active, the current time is NOT displayed on the LCD.

5.11 Weekly timer operation

i INFORMATION
 The following setting procedure is for the wireless remote control only. However, we recommend to perform the weekly timer setting using the ONECTA app. Refer to "5.12 Wireless LAN connection" [▶ 36] for more information.

With this operation, you can save up to 4 timer settings for each day of the week.

Example: Create a different setting from Monday to Friday and a different setting for weekends.

Day of the week	Setting example
Monday <ul style="list-style-type: none"> Make up to 4 settings. 	
Tuesday~Friday <ul style="list-style-type: none"> Use the copy mode if the settings are the same as for Monday. 	
Saturday <ul style="list-style-type: none"> No timer setting 	—
Sunday <ul style="list-style-type: none"> Make up to 4 settings. 	

- **ON-ON-ON-ON setting.** Enables scheduling the operation mode and set temperature.
- **OFF-OFF-OFF-OFF setting.** Only the turn off time can be set for each day.

Note: Be sure to aim the wireless remote control at the indoor unit and check for a receiving tone when setting the Weekly timer operation.

i INFORMATION
 The clock **MUST** be set correctly before using any timer functions. Refer to "4.4.1 To set the clock" [▶ 17].



INFORMATION

- Weekly timer and OFF/ON timer operation CANNOT be used at the same time. The OFF/ON timer operation takes priority. Weekly timer will be in standby, **WEEKLY** disappears from the LCD. When the OFF/ON timer is completed, the Weekly timer becomes active.
- The day of the week, OFF/ON timer mode, time and temperature (only for ON timer) can be set with the Weekly timer. Other settings are based on previous ON timer setting.

5.11.1 To set Weekly timer operation

- 1 Press

Result: The day of the week and the reservation number of the current day are displayed.



- 2 Press or to select the day of the week and the reservation number.
- 3 Press .

Result: The day of the week is set. **WEEKLY** and ON blink.



- 4 Press or to select the mode.

Result: The setting will change as follows:



Display	Feature
ON	ON timer
OFF	OFF timer
Blank	Deletes reservation

- 5 Press .

Result: The OFF/ON timer mode is set. **WEEKLY** and the time blink.



Note: Press to return to the previous screen. If blank is selected, continue to step 9.

- 6 Press or to select the time. The time can be set between 0:00~23:50 in 10-minute intervals.
- 7 Press .

Result: The time is set and **WEEKLY** and the temperature blink.



Note: Press to return to the previous screen. If OFF timer is selected, continue to step 9.

- 8 Press or to select the desired temperature.

Note: The set temperature for the weekly timer is displayed only when setting the weekly timer mode.



INFORMATION

The temperature can be set between 10~32°C on the wireless remote control, however:

- in cooling and automatic operation mode, the unit will operate at minimum 18°C, even if is set to 10~17°C;
- in heating and automatic operation mode, the unit will operate at maximum 30°C, even if is set to 31~32°C.

9 Press **Next**.

Result: The temperature and time are set for the ON timer. The time is set for the OFF timer. The timer lamp lights orange.

Result: A new reservation screen will appear.

10 Repeat the previous procedure to set another reservation or press  to complete the setting.

Result:  WEEKLY is displayed on the LCD.

Note: A reservation can be copied with the same settings to another day. Refer to "5.11.2 To copy reservations" [▶ 34].

5.11.2 To copy reservations

A reservation can be copied to another day. The complete reservation of the selected day of the week will be copied.

1 Press .

2 Press  or  to select the day of the week to be copied.

3 Press **Copy**.

Result: The reservation of the selected day of the week will be copied.

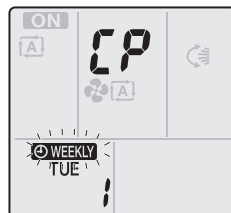

4 Press  or  to select the destination day.

5 Press **Copy**.

Result: The whole reservation is copied to the selected day and the timer lamp lights orange.

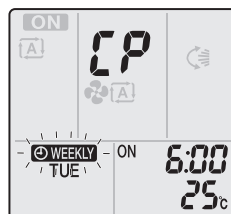

Note: To copy to another day, repeat the procedure.

6 Press  to complete the setting.

Result:  WEEKLY is displayed on the LCD.

Note: To change the reservation setting after copying, refer to "5.11.1 To set Weekly timer operation" [▶ 33].



5.11.3 To confirm reservations

You can confirm if all reservations are set to your needs.

- 1 Press .

Result: The day of the week and the reservation number of the current day are displayed.



- 2 Press  or  to select the day of the week and reservation number to be confirmed and check the reservation details.

Note: To change the reservation setting, refer to "5.11.1 To set Weekly timer operation" [▶ 33].

- 3 Press  to exit the confirmation mode.

5.11.4 To deactivate and reactivate Weekly timer operation

- 1 To deactivate the Weekly timer, press  while  is displayed on the LCD.

Result:  disappears from the LCD and the timer lamp goes off.

- 2 To reactivate the Weekly timer, press  again.

Result: The last set reservation mode will be used.

5.11.5 To delete reservations

To delete individual reservations

Use this function if you want to delete a single reservation setting.

- 1 Press .

Result: The day of the week and the reservation number are displayed.

- 2 Press  or  to select the day of the week to be deleted.

- 3 Press .

Result: , ON, and OFF blink.

- 4 Press  or  and select "blank".

Result: The setting will change as follows:



- 5 Press .



Result: The selected reservation is deleted.

- 6 Press  to exit.

Result: Remaining reservations are active.

To delete a reservation for each day of the week

Use this function if you want to delete all reservation settings for one day of the week. This can be used in confirmation or setting mode.

- 1 Press .
- 2 Press  or  to select the day of the week to be deleted.
- 3 Hold **Weekly** for about 5 seconds.

Result: All reservations for the selected day are deleted.

- 4 Press  to exit.

Result: Remaining reservations are active.

To delete all reservations

Use this function if you want to delete all reservations for all days of the week in one go. This procedure CANNOT be used in the setting mode.

- 1 Hold **Weekly** for about 5 seconds while in the default display.

Result: All reservations will be deleted.

5.12 Wireless LAN connection

Simply connect your unit to your home network and download the app to change the thermostat, set temperature schedules, review your energy consumption and more.

For details on specifications, setting methods, FAQ, troubleshooting tips, visit app.daikineurope.com.

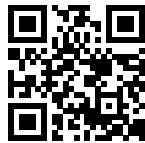

The customer is responsible for providing:

- Smartphone or tablet with minimum supported version of Android or iOS, specified on app.daikineurope.com.
- Internet line and communication device, such as a modem, router, etc.
- Wireless LAN access point
- Installed free ONECTA application

Note: If needed, the SSID number and the KEY are located on the unit or can be found in the accessory bag.

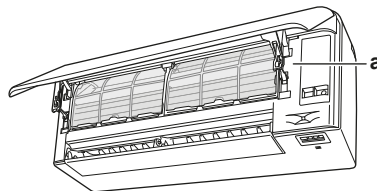

a Label with SSID number and password

5.12.1 Precautions when using the wireless LAN

Do NOT use near:

- **Medical equipment.** E.g. persons using cardiac pacemakers or defibrillators. This product may cause electromagnetic interference.
- **Auto-control equipment.** E.g. automatic doors or fire alarm equipment. This product may cause faulty behaviour of the equipment.

- **Microwave oven.** It may affect wireless LAN communications.

5.12.2 To install the ONECTA app

- 1 Go to Google Play (for Android devices) or the App Store (for iOS devices) and search for "ONECTA".
- 2 Follow the directions on the screen to install the ONECTA app.



INFORMATION

Scan the QR code to download and install the ONECTA app on your mobile phone or tablet:



5.12.3 To set the wireless connection

There are two options to connect the wireless adapter to your home network.

- Using a smart device (smartphone, tablet) and SSID (Service Set Identifier) and KEY (password)
- Using the WPS (Wi-Fi Protected Setup) button on your Wi-Fi router.

For more information and FAQ, refer to app.daikineurope.com.

Note: Setting is done by the wireless remote control in the wireless LAN setting menu. During setting, always aim the wireless remote control at the infrared signal receiver on the unit.



INFORMATION

Make sure operation is stopped before setting the wireless connection. Connection CANNOT be made when the unit is in operation.

- 1 **Stop operation** before setting the wireless connection.
- 2 Make sure the wireless router is close enough to the unit and nothing obstructs the signal.

Menu	Description
<i>!</i>	Connection status check
<i>2</i>	Connection using WPS button
<i>3</i>	Connection using SSID and KEY
<i>R</i>	Reset to factory default
<i>oFF</i>	Wireless LAN OFF

To confirm the wireless LAN connection status

- 1 Hold  for at least 5 seconds.

Result: The confirmation display (menu *!*) appears.

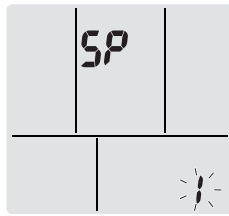

- 2 Press to confirm the selection.

Result: "Beep" sound is heard when the unit receives signal.

- 3 Check the indoor unit LED.

...lamp is blinking.	Status
Timer	Communication is OK
Operation and timer	Communication is OFF

- 4 Press to exit the menu.

Result: The display will return to the default screen.

To connect the wireless LAN to your home network

The wireless adapter can be connected to your home network using the:

- WPS button (Wi-Fi Protected Setup) on the router (if present),
- The SSID (Service Set Identifier) and the KEY (password) - located on the unit.

To connect using the WPS button

- 1 Hold for at least 5 seconds in the default screen.

Result: The confirmation display (menu **1**) appears.

- 2 Press repeatedly or until the WPS setting display (menu **2**) appears.

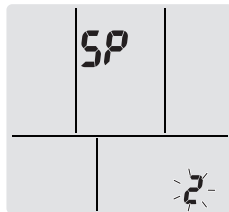

- 3 Press to confirm the selection.

Result: "Beep" sound is heard when the unit receives signal.

- 4 Press the WPS button on your communication device (e.g. router) within approximately 1 minute. Refer to the manual of your communication device.



INFORMATION

If the connection with your router is not possible, try procedure "[To connect using SSID and KEY number](#)" [▶ 38].

- 5 Press to exit the menu.

Result: The display will return to the default screen.

To connect using SSID and KEY number

- 1 Hold for at least 5 seconds in the default screen.

Result: The confirmation display (menu **1**) appears.

- 2 Press repeatedly or until the AP mode display (menu **3**) appears.

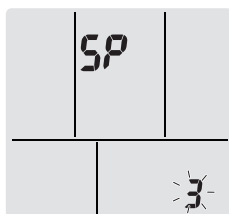

- 3 Press to confirm the selection.

Result: “Beep” sound is heard when the unit receives signal.

- 4 Connect your smart device to the access point in the same way as to a standard wireless network.
- 5 Enter the SSID number and password located on the unit or in the accessory set.
- 6 Open the ONECTA application and follow the steps on the screen.

Result: Wireless adapter mode will automatically change from the AP mode to the RUN mode, the timer LED is blinking.

- 7 Press to exit the menu.

Result: The display will return to the default screen.

To reset the connection setting to the factory default

Reset the connection setting to the factory default in case you want to:

- switch between the WPS and the AP connection option,
- disconnect the Wi-Fi adapter and the communication device (e.g. router) or smart device,
- repeat the setting if the connection was unsuccessful.

- 1 Hold for at least 5 seconds in the default screen.

Result: The confirmation display (menu) appears.

- 2 Press repeatedly or until the menu appears.

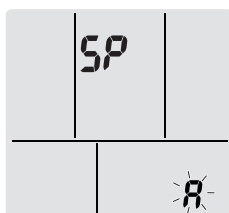

- 3 Hold for at least 2 seconds to confirm the selection.

Result: “Beep” sound is heard when the unit receives signal.

Result: The setting is reset to the factory default.

- 4 Press to exit the menu.

Result: The display will return to the default screen.

To turn off the wireless LAN connection

You can turn off the wireless connection using:

- the wireless adapter ON/OFF button on the unit,
- the user interface.

To use the wireless adapter ON/OFF switch

- 1 Press the wireless adapter ON/OFF switch.

Result: The wireless adapter communication is OFF.

Note: Press the ON/OFF switch again to turn on the wireless adapter.

To use the user interface

- 1 Hold  for at least 5 seconds in the default screen.

Result: The confirmation display (menu *!*) appears.

- 2 Press repeatedly  or  until the OFF menu appears.

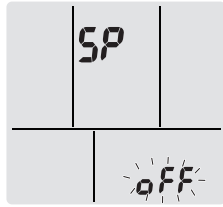

- 3 Hold  for at least 2 seconds to confirm the selection.

Result: “Beep” sound is heard when the unit receives signal.

Result: Communication is OFF.

- 4 Press  to exit the menu.

Result: The display will return to the default screen.

6 Energy saving and optimum operation



INFORMATION

- Even if the unit is turned OFF, it consumes electricity.
- When the power turns back on after a power break, the previously selected mode will be resumed.



CAUTION

NEVER expose little children, plants or animals directly to the airflow.



NOTICE

Do NOT place objects below the indoor and/or outdoor unit that may get wet. Otherwise condensation on the unit or refrigerant pipes, air filter dirt or drain blockage may cause dripping, and objects under the unit may get dirty or damaged.



WARNING

Do NOT place a flammable spray bottle near the air conditioner and do NOT use sprays near the unit. Doing so may result in a fire.



CAUTION

Do NOT operate the system when using a room fumigation-type insecticide. Chemicals could collect in the unit, and endanger the health of people who are hypersensitive to chemicals.

Observe the following precautions to ensure the system operates properly.

- Prevent direct sunlight from entering a room during cooling operation by using curtains or blinds.
- Make sure the area is well ventilated. Do NOT block any ventilation openings.
- Ventilate often. Extended use requires special attention to ventilation.
- Keep doors and windows closed. If the doors and windows remain open, air will flow out of your room causing a decrease in the cooling or heating effect.
- Be careful NOT to cool or heat too much. To save energy, keep the temperature setting at a moderate level.
- NEVER place objects near the air inlet or the air outlet of the unit. Doing so may cause a reduced heating/cooling effect or stop operation.
- Turn off the main power supply switch to the unit when the unit is NOT used for longer periods of time. If the main power supply switch is on, the unit consumes electricity. Before restarting the unit, turn on the main power supply switch 6 hours before operation to ensure smooth running.
- Condensation may form if the humidity is above 80% or if the drain outlet gets blocked.
- Adjust the room temperature properly for a comfortable environment. Avoid excessive heating or cooling. Notice that it may take some time for the room temperature to reach the set temperature. Consider using the timer setting options.
- Adjust the air flow direction to avoid cool air from gathering on the floor or warm air against the ceiling. (Up during cooling or dry operation to the ceiling and down during heating operation.)

- Avoid direct air flow to room inhabitants.
- Operate the system within the recommended temperature range (26~28°C for cooling and 20~24°C for heating) to save energy.

7 Maintenance and service

7.1 Overview: Maintenance and service

The installer has to perform a yearly maintenance.

About the refrigerant

This product contains fluorinated greenhouse gases. Do NOT vent gases into the atmosphere.

Refrigerant type: R32

Global warming potential (GWP) value: 675



NOTICE

Maintenance **MUST** be done by an authorised installer or service agent.

We recommend performing maintenance at least once a year. However, applicable legislation might require shorter maintenance intervals.



WARNING

- The refrigerant inside the unit is mildly flammable, but normally does NOT leak. If the refrigerant leaks in the room and comes in contact with fire from a burner, a heater, or a cooker, this may result in fire, or the formation of a harmful gas.
- Turn OFF any combustible heating devices, ventilate the room, and contact the dealer where you purchased the unit.
- Do NOT use the unit until a service person confirms that the part from which the refrigerant leaked has been repaired.



WARNING

- Do NOT pierce or burn refrigerant cycle parts.
- Do NOT use cleaning materials or means to accelerate the defrosting process other than those recommended by the manufacturer.
- Be aware that the refrigerant inside the system is odourless.



WARNING

The appliance shall be stored so as to prevent mechanical damage and in a well-ventilated room without continuously operating ignition sources (e.g. open flames, an operating gas appliance, or an operating electric heater). The room size shall be as specified in the General safety precaution.



DANGER: RISK OF ELECTROCUTION

To clean the air conditioner or air filter, be sure to stop operation and turn all power supplies OFF. Otherwise, an electrical shock and injury may result.



WARNING

To prevent electrical shocks or fire:

- Do NOT rinse the unit.
- Do NOT operate the unit with wet hands.
- Do NOT place any objects containing water on the unit.



CAUTION

After a long use, check the unit stand and fitting for damage. If damaged, the unit may fall and result in injury.



CAUTION

Do NOT touch the heat exchanger fins. These fins are sharp and could result in cutting injuries.



WARNING

Be careful with ladders when working in high places.

7.2 To clean the indoor unit and wireless remote control



WARNING

Improper detergents or cleaning procedure may cause damage on plastic components or water leakage. Splashed detergent on electric components, such as motors, may cause failure, smoke or ignition.



DANGER: RISK OF ELECTROCUTION

Before cleaning, be sure to stop the operation, turn the breaker OFF or pull out the supply cord. Otherwise, an electrical shock and injury may result.



NOTICE

- Do NOT use gasoline, benzene, thinner, polishing powder or liquid insecticide. **Possible consequence:** Discoloration and deformation.
- Do NOT use water or air of 40°C or higher. **Possible consequence:** Discoloration and deformation.
- Do NOT use polishing compounds.
- Do NOT use a scrubbing brush. **Possible consequence:** The surface finishing peels off.
- As an end user, you may NEVER clean inside parts of the unit by yourself; this work must be performed by a qualified service person. Contact your dealer.

- 1 Clean with a soft cloth. If it is difficult to remove stains, use water or a neutral detergent.

7.3 To clean the front panel

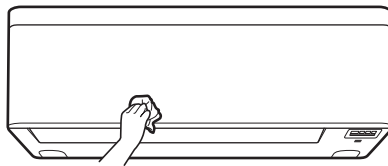

- 1 Clean the front panel with a soft cloth. If it is difficult to remove stains, use water or a neutral detergent.

7.4 To open the front panel

Open the front panel using the user interface.

- 1 Stop operation.
- 2 Hold  on the user interface for at least 2 seconds.

Result: The front panel will open.

Note: Press and hold  again for at least 2 seconds to close the front panel.

- 3 Turn the power supply off.
- 4 Pull down both locks on the back of the front panel.
- 5 Open the front panel until the support fits into the fixing tab.

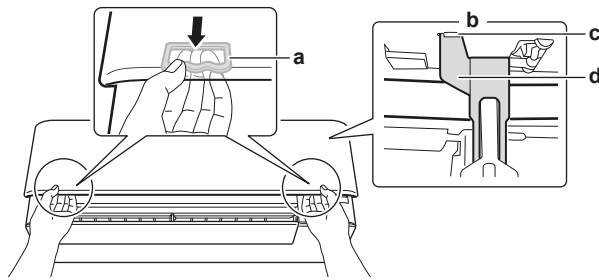

- a Lock (1 on each side)
- b Backside of the front panel
- c Fixing tab
- d Support



INFORMATION

If you CANNOT find the wireless remote control or you use another optional controller. Pull the front panel carefully up by hand as shown in the following figure.

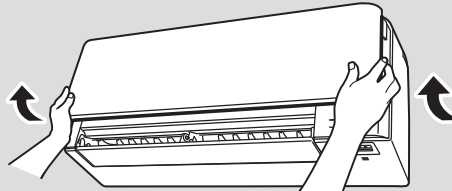

7.5 About the air filters

Operating the unit with dirty filters means that the filter:

- CANNOT deodorise the air,
- CANNOT clean the air,
- poor heating/cooling,
- causes odour.

List of treated articles used in Daikin products based on Regulation (EU) No 528/2012	
Treated article of a biocidal product	Air resin filter
Active substance	Silver phosphate glass
Content	<0,02 %
CAS Nr.	308069-39-8

List of treated articles used in Daikin products based on Regulation (EU) No 528/2012	
Active substancefunction	Antiviral and antibacterial effect
Safety Information	<p>RoHS compliant, non-toxic or corrosive.</p> <p>There are no specific PPE recommendations.</p> <p>Disposal shall comply with government and legal regulations governing the disposal of material.</p> <p>Store in the room temperature.</p> <p>Eye contact - wash with water</p> <p>Skin contact - wash with water, shouldn't affect the skin</p> <p>Inhalation - no specific hazards indicated</p>

7.6 To clean the air filters

- 1 Push the tab at the centre of each air filter, then pull it down.
- 2 Pull out the air filters.

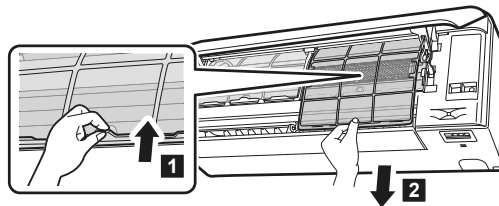

- 3 Remove the titanium apatite deodorising filter and silver particle filter from the tabs.

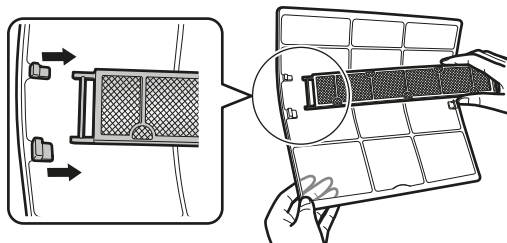

- 4 Wash the air filters with water or clean them with a vacuum cleaner.

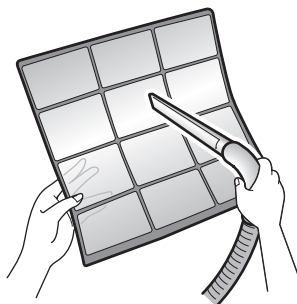

- 5 Soak in lukewarm water for about 10 to 15 minutes.

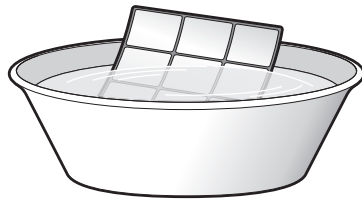
**INFORMATION**

- If the dust does NOT come off easily, wash the air filters with a neutral detergent diluted in lukewarm water. Dry the air filters in the shade.
- Be sure to remove the titanium apatite deodorising and silver particle filters.
- It is recommended to clean the air filters every 2 weeks.

7.7 To clean the titanium apatite deodorising filter and the silver particle filter (Ag-ion filter)

**INFORMATION**

Clean the filter with water every 6 months.

- 1 Remove the titanium apatite deodorising filter and the silver allergen removal air purifying filter from all 4 claws.

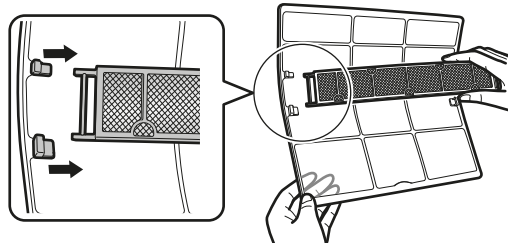

- 2 Remove the dust from the filter with a vacuum cleaner.

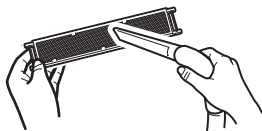

- 3 Soak the filter for 10 to 15 minutes in warm water.

Note: Do NOT remove the filter from the frame.



- 4 After washing, shake off remaining water and dry the filter in the shade. Do NOT wring out the filter when removing water.

7.8 To replace the titanium apatite deodorising filter and the silver particle filter (Ag-ion filter)



INFORMATION

Replace the filter every 3 years.

- 1 Remove the filter from the tabs of the filter frame and replace the filter with a new one.

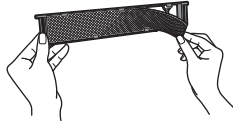

INFORMATION

- Do NOT throw away the filter frame, but use it again.
- Dispose of the old filter as non-flammable waste.

To order titanium apatite deodorising filter or silver particle filters, contact your dealer.

Item	Part number
Titanium deodorising filter	KAF970A46
Silver particle filter	KAF057A41

7.9 To close the front panel

- 1 Set the filters as they were.
- 2 Lift the front panel slightly and remove the support from the fixing tab.

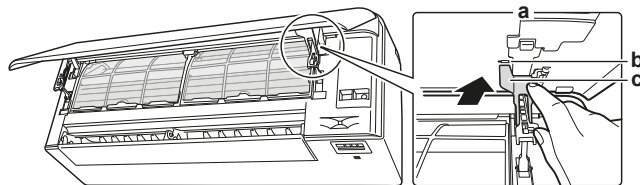

- a Backside of the front panel
- b Fixing tab
- c Support

- 3 Close the front panel.

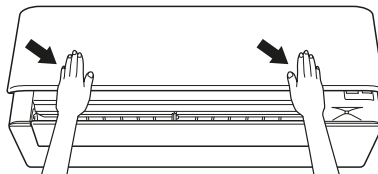

- 4 Gently press the front panel down until it clicks.

7.10 To remove the front panel



INFORMATION

Remove the front panel only in case it **MUST** be replaced.

- 1 Open the front panel. See "[7.4 To open the front panel](#)" [▶ 45].
- 2 Open the panel locks located on the back side of the panel (1 on each side).

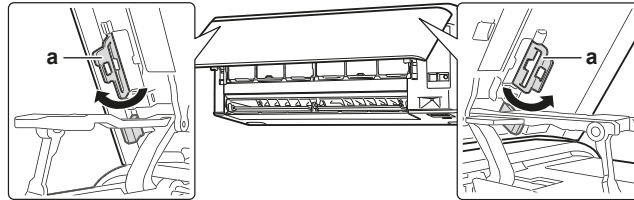

a Panel lock

- 3 Push the right arm lightly to the right to disconnect the shaft from the shaft slot on the right side.

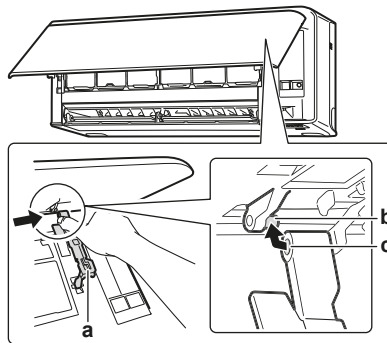

a Arm
b Shaft
c Shaft slot

- 4 Disconnect the front panel shaft from the shaft slot on the left side.

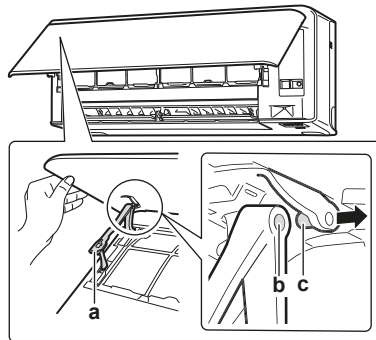



a Arm
b Shaft slot
c Shaft

- 5 Remove the front panel.
- 6 To re-install the front panel perform the steps in the opposite order.

7.11 To take following items into account before a long idle period

Operate the unit several hours in **fan only** mode to dry the inside of the unit.

- 1 Press  and select  operation.

- 2 Press  and start operation.
- 3 After operation stops, turn the breaker OFF.
- 4 Clean the air filters and replace them in their original positions.
- 5 Remove the batteries from the wireless remote control.



INFORMATION

It is recommended to have periodical maintenance performed by a specialist. For specialist maintenance, contact your dealer. Maintenance costs shall be borne by the customer.

In certain operating conditions the inside of the unit may get dirty after several seasons of use. This results in poor performance.

8 Troubleshooting

If one of the following malfunctions occurs, take the measures shown below and contact your dealer.



WARNING

Stop operation and shut OFF the power if anything unusual occurs (burning smells etc.).

Leaving the unit running under such circumstances may cause breakage, electrical shock or fire. Contact your dealer.

The system **MUST** be repaired by a qualified service person.

Malfunction	Measure
If a safety device such as a fuse, a breaker or an earth leakage breaker frequently actuates or the ON/OFF switch does NOT properly work.	Turn OFF the main power switch.
If water leaks from the unit.	Stop the operation.
The operation switch does NOT work well.	Turn OFF the power supply.
If the user interface display indicates the unit number, the operation lamp flashes and the malfunction code appears.	Notify your installer and report the malfunction code.

If the system does NOT operate properly except for the above mentioned cases and none of the above mentioned malfunctions is evident, investigate the system in accordance with the following procedures.

Malfunction	Measure
If the system does NOT operate at all.	<ul style="list-style-type: none"> ▪ Check if there is no power failure. Wait until power is restored. If a power failure occurs during operation, the system automatically restarts immediately after power is restored. ▪ Check if the front panel is opened during operation. Stop operation and restart the indoor unit using the user interface. ▪ Check if no fuse has blown or breaker is activated. Change the fuse or reset the breaker if necessary. ▪ Check the batteries of the user interface. ▪ Check the timer setting.
The system suddenly stops operating.	<ul style="list-style-type: none"> ▪ Check if the air inlet or outlet of the outdoor or indoor unit is NOT blocked by obstacles. Remove any obstacles and make sure the air can flow freely. ▪ The air conditioner may stop operating after sudden large voltage fluctuations to protect the system. It automatically resumes operation after about 3 minutes.
The fan will stop during airflow operation.	If the set temperature is reached, the airflow rate is reduced and operation stops. Operation will resume automatically when the indoor temperature rises or falls.

Malfunction	Measure
The flaps do NOT start to swing immediately.	The indoor unit is adjusting the position of the flaps. The flaps will start moving soon.
Operation does NOT start soon.	In case the ON/OFF button was pressed right after operation was stopped or if the mode was changed. Operation will start after 3 minutes to protect the system.
The system operates, but cooling or heating is insufficient.	<ul style="list-style-type: none"> ▪ Check the airflow rate setting. Refer to "5.4 Airflow rate" [▶ 22]. ▪ Check the temperature setting. Refer to "5.3.1 To start/stop operation mode and to set the temperature" [▶ 22]. ▪ Check if the airflow direction setting is appropriate. Refer to "5.5 Airflow direction" [▶ 23]. ▪ Check if the air inlet or outlet of the outdoor or indoor unit is NOT blocked by obstacles. Remove any obstacles and make sure the air can flow freely. ▪ Check if the air filters are clogged. Clean the air filters. Refer to "7 Maintenance and service" [▶ 43]. ▪ Check for open doors or windows. Close doors and windows to prevent wind from coming in. ▪ Check if the unit operates in Econo or Outdoor unit quiet operation. Refer to "5.8 Econo and Outdoor unit quiet operation" [▶ 27]. ▪ Check if there is any furniture directly under or next to the indoor unit. Move the furniture.
The system operates, but heating is insufficient (air is NOT blown from the unit).	<ul style="list-style-type: none"> ▪ The air conditioner may be warming up for heating operation. Wait for 1 to 4 minutes. ▪ If a flowing sound is heard, the outdoor unit may be in defrost operation. Wait for 4 to 12 minutes.
The front panel does NOT open.	Check for the obstacles and try to open the front panel using the user interface. Refer to "7.4 To open the front panel" [▶ 45].
The ON/OFF timer does NOT operate according to the settings.	<ul style="list-style-type: none"> ▪ Check if the Weekly timer and ON/OFF timer are set to the same time. Change or deactivate the setting. Refer to "5.10 OFF/ON timer operation" [▶ 29] and "5.11 Weekly timer operation" [▶ 32]. ▪ Check if the clock and the day of the week are set correctly. Refer to "4.4 The clock setting" [▶ 17].
Heating operation CANNOT be selected.	<p>Check if the user interface's jumper J8 has NOT been cut.</p> 
An abnormal function happens during operation.	The air conditioner may malfunction because of lightning or radio waves. Turn the breaker OFF and back ON.

Malfunction	Measure
The unit does NOT receive signals from the user interface.	<ul style="list-style-type: none"> Check the batteries of the user interface. Refer to "4.3 To insert the batteries" [▶ 16]. Make sure that the transmitter is NOT exposed to direct sunlight. Check if there are any electronic starter type fluorescent lamps in the room. Contact your dealer.
The user interface display is blank.	Replace the batteries of the user interface.
An error code is displayed on the user interface.	Consult your local dealer. Refer to "8.2 Solving problems based on error codes" [▶ 54] for a detailed list of error codes.
Other electric appliances start to operate.	If the user interface signals operate other electric appliances, move the other appliances away, and contact your dealer.

If after checking all above items, it is impossible to fix the problem yourself, contact your installer and state the symptoms, the complete model name of the unit (with manufacturing number if possible) and the installation date (possibly listed on the warranty card).

8.1 Symptoms that are NOT system malfunctions

The following symptoms are NOT system malfunctions:

8.1.1 Symptom: A sound like water flowing is heard

- This sound is caused by the refrigerant flowing in the unit.
- This sound may be generated when water is flowing away from the unit during cooling or drying operation.

8.1.2 Symptom: A blowing sound is heard

This sound is generated when the direction of the refrigerant flow is changed (e.g. when switching from cooling to heating).

8.1.3 Symptom: A ticking sound is heard

This sound is generated when the unit slightly expands or contracts with changes in temperature.

8.1.4 Symptom: A whistling sound is heard

This sound is generated by the refrigerant flowing during defrost operation.

8.1.5 Symptom: A clicking sound during operation or idle time is heard

This sound is generated when the refrigerant control valves or electrical parts operate.

8.1.6 Symptom: A clapping sound is heard

This sound is generated when an external device sucks air out of the room (e.g. exhaust fan, extractor hood) while the doors and windows in the room are closed. Open the doors or windows, or turn off the device.

8.1.7 Symptom: White mist comes out of a unit (Indoor unit, outdoor unit)

When the system is changed over to heating operation after defrost operation. Moisture generated by defrost becomes steam and is exhausted.

8.1.8 Symptom: The units can give off odours

The unit can absorb the smell of rooms, furniture, cigarettes, etc., and then emit it again.

8.1.9 Symptom: The outdoor fan rotates while the air conditioner is not in operation

- **After operation has stopped.** The outdoor fan continues to rotate for another 30 seconds for system protection.
- **While the air conditioner is not in operation.** When the outdoor temperature is very high, the outdoor fan starts to rotate for system protection.

8.1.10 Symptom: Airflow rate setting does NOT resume when Comfort airflow is deactivated by ONECTA app

If Comfort airflow operation is deactivated by ONECTA app, the airflow rate does NOT return to previous airflow rate setting, and indoor unit operates in automatic airflow rate.

8.1.11 Symptom: Some operation icons are not visible on the wireless remote control, or some functions cannot be activated in the ONECTA app

Some combinations of features are not permitted (example: Fan only mode and Outdoor unit quiet operation). This features may display at the ONECTA app, but function CANNOT be activated.

8.1.12 Symptom: In ONECTA app, powerful operation is NOT indicated as active

When the powerful operation is activated while indoor unit is OFF, the powerful operation may not be displayed as active for 2 minutes until the cloud data are updated.

8.2 Solving problems based on error codes

Fault diagnosis by the wireless remote control

If the unit runs into a problem, you can identify the fault by checking the error code by the wireless remote control. It is important to understand the problem and take measures before resetting the error code. This should be done by a licensed installer or your local dealer.

**INFORMATION**

See the service manual for:

- The complete list of error codes
- A more detailed troubleshooting guideline for each error

To check the error code by the wireless remote control

- 1 Aim the wireless remote control at the unit and press **Cancel** for about 5 seconds.

Result: **00** blinks in the temperature setting display section.

- 2 Aim the wireless remote control at the unit and press **Cancel** repeatedly until a continuous beep is heard.

Result: The code is now displayed on the display.

**INFORMATION**

- A short beep and 2 consecutive beeps indicate non-corresponding codes.
- To cancel the code display, hold **Cancel** for 5 seconds. The code will also disappear from the display if the button is NOT pressed within 1 minute.

System

Error code	Description
00	Normal
U0	Refrigerant shortage
U2	Overvoltage detection
U4	Signal transmission error (between indoor and outdoor unit)
UR	Indoor/outdoor unit combination fault

Indoor unit

Error code	Description
R1	Indoor unit PCB abnormality
R5	Freeze-up protection or high-pressure control
R6	Fan motor (DC motor) abnormality
RR	Streamer unit error
E4	Indoor heat exchanger thermistor abnormality
E7	Opening or closing front panel error
E9	Room temperature thermistor abnormality
E1	Humidity sensor error

Outdoor unit

Error code	Description
ER	4-way valve abnormality
E1	Outdoor unit PCB abnormality
E5	Overload activation (compressor overload)
E6	Compressor lock

Error code	Description
E7	DC fan lock
E8	Input power overcurrent
F3	Discharge pipe temperature control
F6	High-pressure control (in cooling mode)
H0	Compressor system sensor abnormality
H6	Position sensor abnormality
H8	DC voltage / current sensor abnormality
H9	Outdoor temperature thermistor abnormality
J3	Discharge pipe thermistor abnormality
J6	Outdoor heat exchanger thermistor abnormality
L3	Electrical parts heat error
L4	Radiation fin temperature rise
L5	Inverter instantaneous overcurrent (DC)
P4	Radiation fin thermistor abnormality
F8	Compressor internal temperature error

8.3 Troubleshooting for wireless LAN connection

The following table provides a brief description of how to deal with some problems. If none of the following solutions fix the problem, go to app.daikineurope.com for more information and FAQ.

Problem	Measure
Connection to the WLAN adapter is not possible (none of the LEDs are blinking).	<ul style="list-style-type: none"> ▪ Try operating the unit with the user interface. ▪ Check if the power is on. ▪ Turn the unit off and back on again.
The WLAN adapter is NOT visible on the unit overview screen (Home screen) after configuration of the WLAN adapter (WPS option).	<ul style="list-style-type: none"> ▪ Make sure the wireless LAN adapter is close enough to the communication device. ▪ Check if communication is OK. ▪ Make sure that the smart device is connected to the same wireless network as the WLAN adapter. ▪ Try resetting to the factory default and repeat the setting. See "To reset the connection setting to the factory default" [▶ 39].

Problem	Measure
<p>The WLAN adapter is NOT visible in the available Wi-Fi networks list on the smart device (Access point option).</p>	<ul style="list-style-type: none"> ▪ Try switching between access point and WPS setting to change the wireless channel. The wireless channel MUST be between 1~11. ▪ Check if communication is OK. ▪ Try resetting to the factory default and repeat the setting. See "To reset the connection setting to the factory default" [▶ 39].
<p>Displayed indoor/outdoor temperature/humidity value in Online Controller differs from the value measured by other appliances.</p>	<ul style="list-style-type: none"> ▪ Online Controller displays indoor/outdoor temperature/ humidity only for the indoor/outdoor unit's surrounding. ▪ Measured temperature/humidity for other appliances may differ due to different condition around the unit (e.g. direct sunlight, frost accumulation...) ▪ Temperature/humidity displayed in Online Controller is only referential.

9 Disposal



NOTICE

Do NOT try to dismantle the system yourself: dismantling of the system, treatment of the refrigerant, oil and other parts **MUST** comply with applicable legislation. Units **MUST** be treated at a specialised treatment facility for reuse, recycling and recovery.

10 Glossary

Dealer

Sales distributor for the product.

Authorised installer

Technical skilled person who is qualified to install the product.

User

Person who is owner of the product and/or operates the product.

Applicable legislation

All international, European, national and local directives, laws, regulations and/or codes that are relevant and applicable for a certain product or domain.

Service company

Qualified company which can perform or coordinate the required service to the product.

Installation manual

Instruction manual specified for a certain product or application, explaining how to install, configure and maintain it.

Operation manual

Instruction manual specified for a certain product or application, explaining how to operate it.

Accessories

Labels, manuals, information sheets and equipment that are delivered with the product and that need to be installed according to the instructions in the accompanying documentation.

Optional equipment

Equipment made or approved by Daikin that can be combined with the product according to the instructions in the accompanying documentation.

Field supply

Equipment NOT made by Daikin that can be combined with the product according to the instructions in the accompanying documentation.

DAIKIN INDUSTRIES CZECH REPUBLIC s.r.o.

U Nové Hospody 1/1155, 301 00 Plzeň Skvrňany, Czech Republic

DAIKIN EUROPE N.V.

Zandvoordestraat 300, B-8400 Oostende, Belgium

Copyright 2023 Daikin

4P518786-10L 2023.10